

HI98198 opdo™

Optical Dissolved Oxygen Meter



INSTRUCTION MANUAL

Dear Customer,

Thank you for choosing a Hanna Instruments product.

Please read this instruction manual carefully before using the meter.

This manual will provide you with the necessary information for correct use of the meter, as well as a precise idea of its versatility.

If you need additional technical information, do not hesitate to e-mail us at tech@hannainst.com or view our worldwide contact list at www.hannainst.com.

All rights are reserved. Reproduction in whole or in part is prohibited without the written consent of the copyright owner, Hanna Instruments Inc., Woonsocket, Rhode Island, 02895, USA.

PRELIMINARY EXAMINATION	4
GENERAL DESCRIPTION	5
FUNCTIONAL DESCRIPTION	6
SPECIFICATIONS	8
THEORY OF OPERATION	9
PROBE COMPONENTS	10
GETTING STARTED	11
SETUP	13
DO CALIBRATION	27
PRESSURE CALIBRATION.....	32
TEMPERATURE CALIBRATION.....	33
GOOD LABORATORY PRACTICE (GLP)	35
MEASUREMENT.....	36
LOGGING.....	37
RETRIEVING DATA.....	39
OPERATIONAL GUIDE.....	41
BOD MEASUREMENT.....	42
OUR MEASUREMENT	46
SOUR MEASUREMENT	48
BATTERIES REPLACEMENT.....	52
PROBE MAINTENANCE.....	53
TROUBLESHOOTING GUIDE.....	55
ACCESSORIES.....	56
CERTIFICATION.....	58
RECOMMENDATIONS FOR USERS.....	59
WARRANTY.....	59

Remove **HI98198 opdo™** meter from the packing material and examine it carefully to make sure that no damage has occurred during shipment. If noticeable damage is evident, contact your local Hanna Instruments office.

Each meter is supplied with:

- **HI764113** Optical *DO* probe with built-in temperature sensor, protective shield and 4 m (13'4) cable
- **HI764113-1** Smart Cap™ with o-ring
- **HI7040** Bicomponent Zero Oxygen Solution
- Calibration/storage vessel
- 100 mL plastic beaker (2 pcs.)
- 6 g sachet with silicone grease
- syringe
- 1 lens wipe
- 1.5V AA batteries (4 pcs.)
- Instruction manual
- Meter quality certificate
- Probe quality certificate
- Cap quality certificate
- USB Type A to C cable

Note: Save all packing material until you are sure that the meter functions correctly. All defective items must be returned in the original packing with the supplied accessories.

The **HI98198 opdo™** meter is a rugged, portable dedicated dissolved oxygen (DO) meter designed for fresh and saltwater measurements of dissolved oxygen. This professional, waterproof meter complies with IP67 standards and measures DO, barometric pressure, and temperature. The **HI98198** is supplied with a **HI764113** digital optical dissolved oxygen probe in a custom thermoformed durable carrying case with accessories. It is compact and ergonomically designed to provide ready access to the materials required for routine sampling.

The **HI98198 opdo™** meter is only compatible with the Hanna digital dissolved oxygen probe (**HI764113**).

Concentration measurements are automatically compensated for barometric pressure, temperature and salinity. Barometric pressure and temperature are automatically measured and compensated. Salinity is automatically compensated by setting manually the salinity concentration of the water being measured. The meter also has a built in application to measure and calculate *BOD* (Biological Oxygen Demand), *OUR* (Oxygen uptake rate), and *SOUR* (Specific Oxygen Update Rate).

Other features include:

- Text messages on the graphic LCD display to warn and guide the user.
- Back lighted display.
- One or two points calibration at 0 or/and 100% saturation (with auto recognition).
- A single point manual calibration in mg/L or % saturation using a reference method for calibration value.
- A dedicated **HELP** key for assistance anytime.
- A user selectable “Calibration due” warning.
- A dedicated **GLP** key that includes at last 5 calibrations with time, date, calibration points as well as barometric pressure, temperature and salinity setting.
- AutoEnd freezes the next stable measurement value on the display.
- Log on demand with 4000 records capability.
- USB-C port for easy data transfer to memory stick, PC or other compatible device.

FRONT VIEW

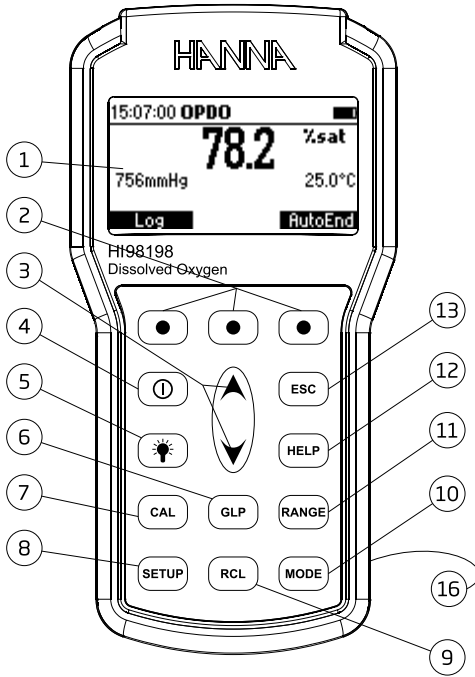

TOP VIEW



- 1) Liquid Crystal Display (LCD).
- 2) F1, F2, F3 functional keys.
- 3) ▲ / ▼ keys to manually increase/decrease the parameters or to scroll through the menu.
- 4) ON/OFF (⏻) key, to turn the meter ON and OFF.
- 5) LIGHT (💡) key, to toggle display back-lighting.
- 6) GLP key, to display Good Laboratory Practice information.
- 7) CAL key, to enter/exit calibration menu.
- 8) SETUP key, to enter/exit Setup menu.
- 9) RCL key, to enter/exit view logged data mode (RCL means RECALL).
- 10) MODE key to switch between *DO*, *BOD*, *OUR* and *SOUR* applications.
- 11) RANGE key, to change between % saturation or concentration in *DO* measurement mode.
- 12) HELP key to enter/exit contextual help.
- 13) ESC key to leave current mode, exit calibration, setup, help, etc.
- 14) Quick connect **DIN** connector.
- 15) **USB-C** connector.
- 16) Junction for barometric pressure sensor.

HI98198 Meter with HI764113 Probe Specifications

Dissolved Oxygen	Range	0.00 to 50.00 mg/L / 0.0 to 500.0% saturation
	Resolution	0.01 mg/L / 0.1% saturation
	Accuracy	1.5% of reading \pm 0.01 mg/L for 0.00-20.00mg/L 5% of reading for 20.00-50.00mg/L 1.5% of reading \pm 0.1% for 00-200.0% 5% of reading for 200.0-500.0%
Barometric Pressure	Range	420 to 850 mmHg
	Resolution	1 mmHg
	Accuracy	\pm 3 mmHg within \pm 15% from the calibration point
Temperature	Range	-5.0 to 50.0 °C (23 to 122 °F)
	Resolution	0.1 °C (0.1 °F)
	Accuracy	\pm 0.3 °C (\pm 0.4 °F)
DO Calibration	<ul style="list-style-type: none"> • One or two points automatic calibration at 100% (8.26 mg/L) and 0% (0 mg/L). • Single point manual using a value entered by the user in % saturation or mg/L. 	
Temperature Calibration	Single point anywhere within temperature range	
Pressure Calibration	Single point anywhere within pressure range	
Temperature Compensation	Automatic from -5.0 to 50.0 °C (23.0 to 122.0 °F)	
Pressure Compensation	Automatic from 420 to 850 mmHg	
Salinity Compensation	Automatic from 0 to 70 PSU (manually set)	
DO Probe	HI764113 Optical Probe	
LOG	On demand with 4000 records capability	
Battery Type / Life	1.5V AA batteries (4 pcs.) / approx. 200 hours of continuous use without backlight (50 hours with backlight)	
Auto Power Off	User selectable: 5, 10, 30, 60 minutes or disabled	
PC Connectivity	USB-C	
Dimensions	185 x 93 x 35.2 mm (7.3 x 3.6 x 1.4")	
Meter Weight (with batteries)	450 g (15.9 oz)	
Case Ingress Protection Rating	IP67	
Environment	0 to 50 °C (32 to 122 °F) max. RH 100%	

HI764113 Probe Specifications

Probe body material	ABS
Smart Cap™ material	Polypropylene
Cable jacket material	PVC
Cable length	4 m (13.1 ft.), 10 m (32.8 ft.), and 20 m (65.6 ft.) options
Probe guard	316 Stainless Steel
Temperature Measurement	Thermistor
Pressure	20 m (29 PSI)
Probe Dimensions (with Guard)	174 X 25 mm (6.8 X 1")
Response Time (t95)	45 seconds
Probe Weight (with Guard)	400 g (14.2 oz) 4 m (13.1 ft.) cable length
Probe Ingress Protection Rating	IP68
Sensor type	Optical; Luminescence Quenching
Origin	Assembled in USA

THEORY OF OPERATION

The Hanna HI764113 optical *DO* sensing probe is based on the principle of fluorescence quenching. The sensing method features an immobilized Pt based luminophore that is excited by the light of a blue LED and emits a red light. Dissolved oxygen quenches this excitation. When there is no oxygen present, the lifetime of the signal is the greatest; as oxygen hits the sensing surface, the lifetime becomes shorter. The intensity and lifetime are inversely proportional to the amount of oxygen present; as oxygen interacts with the luminophore it reduces the intensity and lifetime of the luminescence. The lifetime of the luminescence is measured by a photodetector, and is used to calculate the dissolved oxygen concentration. This is in turn reported by the meter as a % saturation or mg/L reading of Dissolved Oxygen.

The major components of the probe include a blue LED for excitation, a red LED that is used as a reference light, and a photodetector. The Smart Cap™ is locked in place on the optical probe and includes the immobilized O₂ sensitive luminophore with rugged insoluble black oxygen permeable protective layer. Over time, the sensor's optical components can age but are compensated for by using the reference signal to compensate the measuring path. As a result, the sensor provides accurate *DO* measurements over long periods of time without the need for frequent calibration.

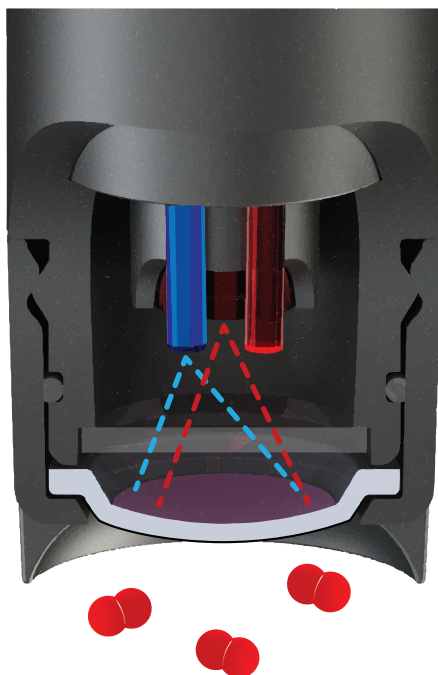

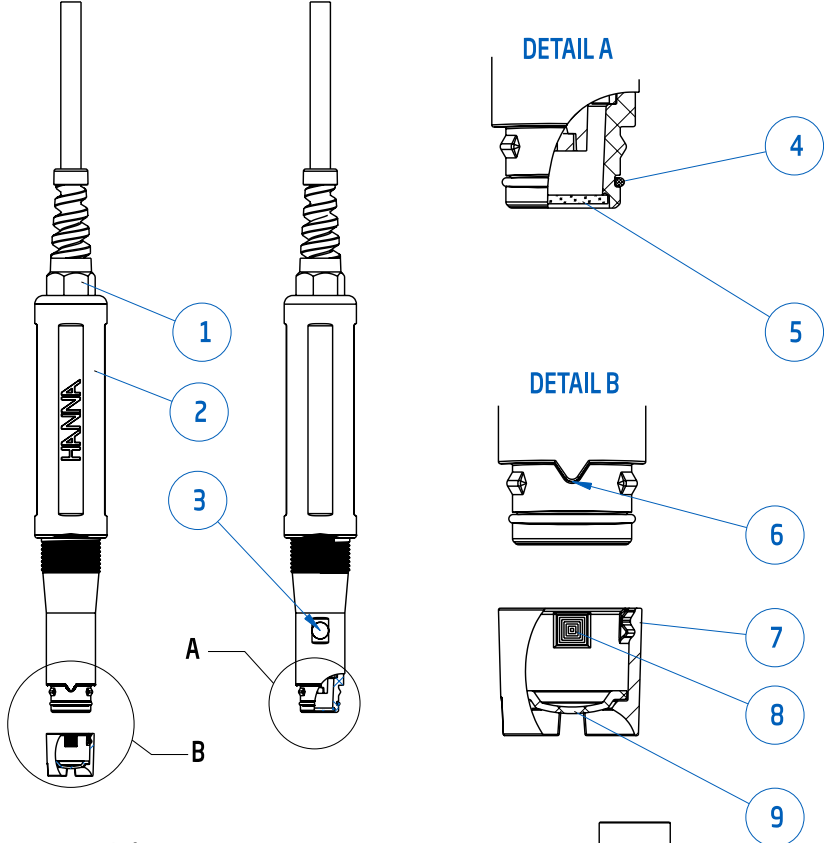

1. Strain relief
2. ABS Probe body
3. Temperature Sensor
4. O-Ring Seal
5. Optical window
6. Alignment key
7. Smart Cap™
8. RFID Tag
9. Embedded O₂ sensitive luminophore with black protective layer
10. Protective shield

INITIAL PREPARATION

Install the supplied batteries into the meter. See *Batteries Replacement* for details, page 52.

To prepare the meter for field measurements close the *USB* communication socket with the attached stopper.

Turn the meter **ON** by pressing **ON/OFF** key.

At start-up the meter will show the Hanna Instruments logo for a few seconds, followed by the percentage indication of the remaining battery life.

Before connecting the probe for the first time, press **SETUP** and using **▲/▼** arrows navigate to *Date/Time*. Press **Modify** and set the current date and time.

Note: Verify time and date are properly set on meter prior to probe initialization.

1. Remove the **HI764113** from the carrying case. Remove stainless steel guard from probe body if it was installed. Use care not to leave fingerprints on the optical window.

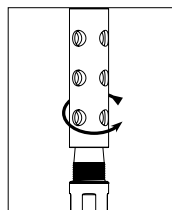

2. Remove the syringe plunger; cut top off supplied sachet with silicone grease and empty contents into the syringe. Using the syringe, sparingly lubricate the O-ring with a thin film of the supplied grease. Avoid getting any kind of grease or fingerprints onto the optical window.

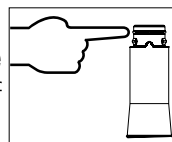

3. Remove the **HI764113-1** optical cap from the container. Align the notched cutout arrow on the Smart Cap™ with the matching guide on the probe body.

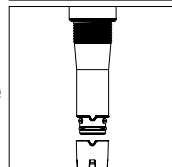

4. Slide and press the Smart Cap™ onto the **HI764113** body until the cap snaps in place. Once the cap is installed, it should not be removed unless a new cap is required.

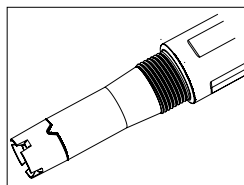

5. Connect the **HI764113** probe to the **HI98198** meter by plugging the DIN connector to the socket located on the top of the meter.

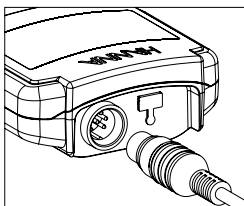

6. Power the meter to initiate the cap timer.



Note: Turn off the meter before connecting or disconnecting the probe.

A probe info screen will be displayed momentarily before defaulting to the measurement screen:

Probe Info		
Probe:	HI764113	v1.00.1
Type:	Optical DO	
Cap:	12 months remaining Initializing..	

16:26:05	OPDO	
	78.2	%sat
756mmHg		25.0°C
Log		AutoEnd

“No Probe” message is displayed on meter if the probe connector is not plugged in properly.

The “No cap info detected. Install the cap and press Continue.” message on the meter indicates that the Smart Cap™ is missing or not properly installed on the probe.

No conditioning period is required when using a [HI764113 DO](#) probe.

Store the [HI764113](#) probe in the [HI98198](#) carrying case when not in use.

For frequent use and short term storage it is recommended to remove the stainless steel guard and replace with the storage vessel that has a small amount of deionized water. The probe can also be stored with the stainless steel guard on in a beaker containing deionized water.

For longer term storage, remove the stainless steel guard and replace with the storage vessel.

Setup menu allows viewing and modifying the measurement parameters.

The following table lists the *Setup* parameters, their valid range and the factory default settings.

Item	Description	Valid value	Default
Log Separator	Log file column separator	Comma, Semicolon	Comma
Salinity	The solution's salt content	0 to 70 PSU	0 PSU
Manual Pressure	Used to manually set the pressure and disable the automatic barometer measurement	Enabled or disabled	Disabled
Pressure Unit		mmHg, inHg, atm, mbar, psi, kPa	mmHg
Temperature Unit		°C or °F	°C
Calibration Timeout	Calibration due timer	Disabled, 10 to 70 days	Disabled
BOD Configuration			
Sample min delta DO	The minimum diff. between the start and the end <i>DO</i> val.	0.00 to 50.00 mg/L	0.00 mg/L
Sample min end DO	The minimum end <i>DO</i> value	0.00 to 50.00 mg/L	0.00 mg/L
Seed min delta DO	The minimum diff. between the start and the end <i>DO</i> val.	0.00 to 50.00 mg/L	0.00 mg/L
Seed min end DO	The minimum end <i>DO</i> value	0.00 to 50.00 mg/L	0.00 mg/L
OUR Configuration			
Min time	The minimum time for the <i>OUR</i> test	1 to 3600s	1s
Max time	The maximum time for the <i>OUR</i> test	1 to 3600s	3600s
Min start DO	The minimum <i>DO</i> value for starting the <i>OUR</i> test	0.01 to 50.00 mg/L	0.01 mg/L
Min end DO	The minimum <i>DO</i> value at the end of the <i>OUR</i> test	0.00 to 50.00 mg/L	0.00 mg/L
Total volume	The total volume of the solution to be tested	0.1 to 300.0 mL	0.1 mL
Sample volume	The volume of sample in the solution to be tested	0.1 to 300.0 mL	0.1 mL
SOUR configuration			
Min time	The minimum time for the <i>SOUR</i> test	1 to 3600s	1s
Max time	The maximum time for the <i>SOUR</i> test	1 to 3600s	3600s
Min start DO	The minimum <i>DO</i> value for starting the <i>SOUR</i> test	0.01 to 50.00 mg/L	0.01 mg/L

Item	Description	Valid value	Default
Min end DO	The minimum <i>DO</i> value at the end of the test	0.00 to 50.00 mg/L	0.00 mg/L
Total volume	The total volume of the solution to be tested	0.1 to 300.0 mL 0.1 to 300.0 mL	0.1 mL 0.1 mL
Sample volume	The volume of sample in the solution to be tested		
Solids weight	Total solids or Volatile Suspended solids weight	0.1 to 300.0 g/L	0.1 g/L
SOUR @ 20 °C	Correct the <i>SOUR</i> value to 20 °C	Enabled or Disabled	Disabled
Autodelete <i>BOD</i> start data	Automatically delete <i>BOD</i> start data, after <i>BOD</i> compute	Enabled or Disabled	Disabled
Backlight	Backlight Level	1 to 7	4
Contrast	Contrast Level	0 to 20	10
Auto Light OFF	Time backlight remains ON	1, 5, 10, 30 minutes	1
Auto Power OFF	Time until meter is powered OFF	Disabled or 5, 10, 30, 60 minutes	30
Date / Time		01.01.2006 to 12.31.2099 00 :00 to 23 :59	current date/ time
Time Format		AM/PM or 24 hours	24 hours
Date Format		DD / MM / YYYY MM / DD / YYYY YYYY / MM / DD YYYY / MM / DD YYYY - MM - DD Mon DD, YYYY DD - Mon - YYYY YYYY-Mon-DD	YYYY/MM/ DD
Language	Message display language	Up to 3 languages	English
Beep ON	Beeper Status	Enabled or Disabled	Disabled
Instrument ID	Meter identification	0000 to 9999	0000
Meter Info	Displays general information		
Probe Info	Displays probe and cap information		

PARAMETER SCREENS

Log Separator

Log separator or CSV file separator is a special character used to separate columns in the CSV log file. There are two options available: Comma (,) or Semicolon (;). The field separator depends upon regional preferences.

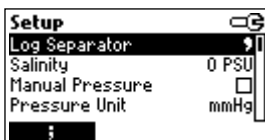

Press the function key to modify the CSV file separator.

Salinity

Dissolved oxygen solubility decreases if water contains salts. This parameter is used to compensate concentration measurements (mg/L) made in brackish or sea water samples. The salinity is expressed in PSU scale and is manually entered by the user. The DO concentration will be automatically compensated to improve the accuracy during calibration and measurement. Enter the salinity value to be close to the known salt level of the sample. Seawater typically has a salinity of 35 and the oxygen solubility is 18% less as compared to fresh water at 25 °C. By entering the approximate salinity value, the calibration and subsequent concentration measurement will be compensated to display the correct oxygen concentration. An 18% error would result if the salinity value is not entered.

Highlight *Salinity*.

Press **Modify**.

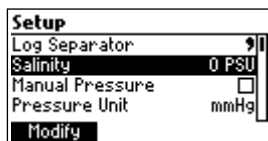

Use ▲/▼ keys to change the salinity value. Press **Accept** to confirm or **ESC** to exit without saving.

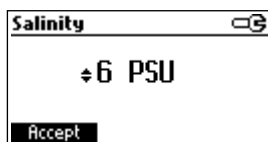

Manual Pressure

The HI98198 has a built in barometer for automatic compensation of ambient pressure for oxygen measurement. The user may enable *Manual Pressure* to disregard the barometer measurement and manually enter a pressure value which will be used for oxygen measurements. Once enabled, pressure values are entered from the measurement screen using the ▲/▼ keys.

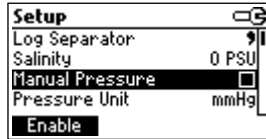

Highlight *Manual pressure*.

Press the displayed functional key to enable or disable the feature.

Pressure Unit

The HI98198 has the ability to convert and display pressure measurements in user selected units. Automatic and Manual Pressure will utilize these units.

To change the pressure measurement unit highlight *Pressure unit* and press **Modify**.

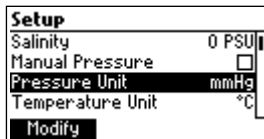

Using ▲/▼ keys highlight the desired pressure measurement unit.

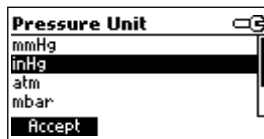

Press **Accept** to confirm or **ESC** to exit without saving.

Temperature Unit

The HI98198 has the ability to convert and display temperature measurements in degree Celsius or Fahrenheit.

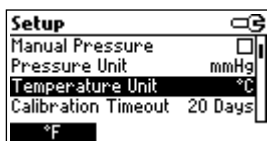

Highlight *Temperature Unit*.

To change the temperature unit, press the displayed functional key.

Calibration Timeout

The HI764113 dissolved oxygen probe utilizes optical technology which offers significant advantages over polarographic or galvanic type dissolved oxygen probes. Some advantages include reduced maintenance, simplified handling and infrequent calibrations. However if a user wishes to validate or calibrate on a *SOP* schedule, a timer may be set as a reminder.

The *Calibration time out* parameter can be set from 10 to 70 days or can be disabled.

The meter is provided with a real time clock (*RTC*) and is used to monitor the time elapsed since the last *DO* calibration.

The calibration timer is reset every time the meter is calibrated and the “*CAL DUE*” status is triggered when the meter detects a calibration time out. The “*CAL DUE*” tags will start blinking to warn the user that the meter should be recalibrated.

If the calibration timeout is changed (e.g. to 20 days), then the timer will be immediately reset.

Notes:

- Before the *DO* calibration is cleared (default values loaded) the display always shows the “*CAL DUE*”.
- Before an abnormal condition in the *RTC* is detected, the meter forces the “*CAL DUE*” status.
- After a user temperature or pressure calibration is made (or cleared), the “*CAL DUE*” message will be activated.

Press **SETUP** key.
 Highlight *Calibration timeout*.

Press **Modify**.
 Use the ▲/▼ keys to set the desired value.
 Press **Accept** to confirm or **ESC** to return without saving.

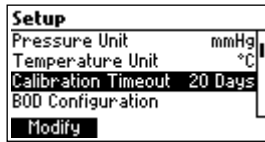

Note: If enabled, a "CAL DUE" warning will be shown on the display after the Calibration timeout period has expired.

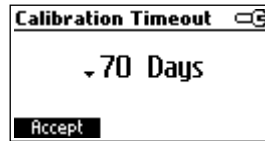

BOD Configuration

When making *BOD* measurements, the *BOD* method configuration parameters must be filled in. These parameters will be used to flag error limits for the determination. Ignore this parameter if not making *BOD* measurements.

Highlight *BOD configuration*.
 Press **Select**.

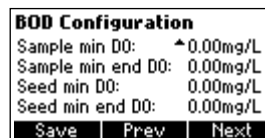
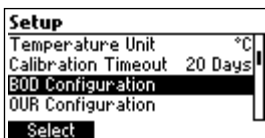

Press ▲/▼ keys to modify the selected parameter's value.

Press **Prev/Next** to select a different parameter.

Press **Save** to save the new *BOD* configuration.

Press **ESC** to leave without changing.

Parameters:

- **Sample min Δ DO** - the minimum acceptable difference between the initial and final *DO* values for a sample. If the difference is less than this value the meter will show a warning message when evaluating the *BOD*.
Range: 0.00 to 50.00 mg/L.
- **Sample min end DO** - the minimum acceptable final *DO* value for a sample. If the final *DO* value is less than this value the meter will show a warning message when evaluating the *BOD*.
Range: 0.00 to 50.00 mg/L.
- **Seed min Δ DO** - the minimum acceptable difference between the initial and final *DO* values for a seed sample. If the difference is less than this value the meter will show a warning message when evaluating the *BOD*.
Range: 0.00 to 50.00 mg/L.
- **Seed min end DO** - the minimum acceptable final *DO* value is less than this value the meter will show a warning message when evaluating the *BOD*.
Range: 0.00 to 50.00 mg/L.

OUR Configuration

The *OUR* method configuration allows the user to set the parameters related to the *OUR* measurement. *OUR* is used to determine the oxygen consumption or respiration rate. It is defined as the mg/L of oxygen consumed per hour.

These parameters will be used to flag error limits and make dilution calculations for the determination.

Ignore this parameter if not making *OUR* measurements.

Highlight *OUR configuration* and press **Select**.

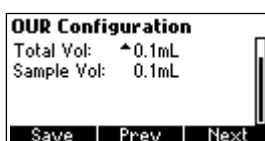
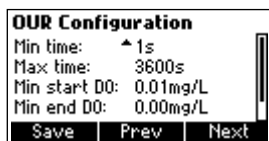
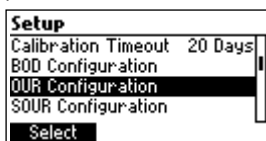

Press ▲/▼ keys to modify the selected parameter's value.

Press **Prev/Next** to select a different parameter.

Press **Save** to save the new *OUR* configuration.

Press **ESC** to leave without changing.

Parameters:

- **Min time** - the minimum time for the *OUR* test.
Range: 1 to 3600 seconds.
- **Max time** - the maximum time for the *OUR* test. The test will stop automatically when the maximum time has elapsed.
Range: 1 to 3600 seconds.
- **Min start DO** - the minimum accepted *DO* value for starting the *OUR* test. If the *DO* reading is less than this value the test cannot be started.
Range: 0.01 to 50.00 mg/L.
- **Min end DO** - the minimum accepted *DO* value at the end of the test. If the *DO* reading at the end of the *OUR* test is less than this value a warning message will be displayed.
Range: 0.00 to 50.00 mg/L.
- **Total volume** - the volume of the diluted mixture.
Range: 0.1 to 300.0 mL
- **Sample volume** - the volume of sample in the diluted mixture.
Range: 0.1 to 300.0 mL.

SOUR Configuration

Specific Oxygen Uptake Rate (*SOUR*), also known as the oxygen consumption or respiration rate, is defined as the milligram of oxygen consumed per gram of volatile suspended solids (*VSS*) per hour. These parameters will be used to flag error limits and make dilution calculations for the determination.

Ignore this parameter if not making *SOUR* measurements.

Highlight *SOUR configuration* and press **Select**.

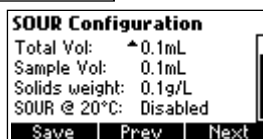
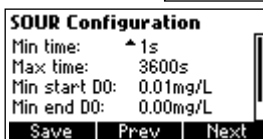
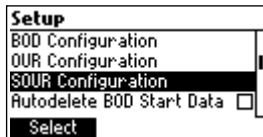

Press ▲/▼ keys to modify the selected parameter's value.

Press **Prev/Next** to select a different parameter.

Press **Save** to save the new *SOUR* configuration.

Press **ESC** to leave without changing.

- **Min time** - the minimum time for the *SOUR* test.
Range: 1 to 3600 seconds.
- **Max time** - the maximum time for the *SOUR* test. The test will stop automatically when the maximum time has elapsed.
Range: 1 to 3600 seconds.
- **Min start DO** - the minimum accepted *DO* value for starting the *SOUR* test. If the *DO* reading is less than this value the test cannot be started.
Range: 0.01 to 50.00 mg/L.
- **Min end DO** - the minimum accepted *DO* value at the end of the test. If the *DO* reading at the end of the *SOUR* test is less than this value a warning message will be displayed.
Range: 0.00 to 50.00 mg/L.
- **Total volume** - the volume of the diluted mixture.
Range: 0.1 to 300.0 mL
- **Sample volume** - the volume of sample in the diluted mixture.
Range: 0.1 to 300.0 mL.
- **Solids weight**: Total solids or Volatile suspended solids weight.
Range: 0.1 to 300.0 g/L.
- **SOUR @ 20°C**: If this option to enabled the *SOUR* value is corrected to 20 °C.

Autodelete BOD start data

Highlight *Autodelete BOD start data*.

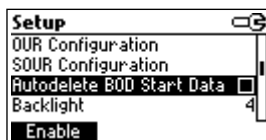

Press the displayed functional key to enable/disable the feature.

If enabled the *BOD* initial data record used in *BOD* result evaluation is deleted automatically after the *BOD* result has been saved into the meter's memory (**LOG** key pressed).

If disabled, the user has to delete *BOD* initial data records that were used in *BOD* result evaluation, entering *View initial BOD data mode*.

Backlight

The display backlight can be adjusted to increase visibility in various lighting environments.

To adjust the backlight, highlight *Backlight* and press **Modify**.

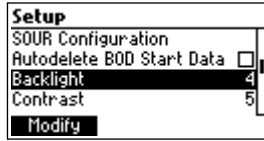

Use ←/→ keys to change intensity, then press **Accept** to confirm.

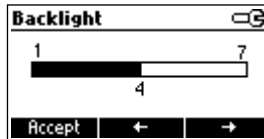

Press **ESC** to leave without changing.

Contrast

The display contrast ratio adjusts the ratio of light areas to dark areas to improve readability in various environments.

To adjust the contrast, highlight *Contrast* and press **Modify**.

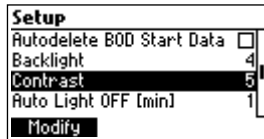

Use ←/→ keys to change intensity, then press **Accept** to confirm.

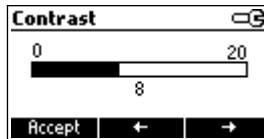

Press **ESC** to leave without changing.

Auto Light OFF

The backlight must be manually enabled by pressing the light bulb key on the keypad. When the selected time has expired, back lighting turns off automatically.

To change the duration, highlight *Auto Light OFF* than press the desired functional key to change the option.

The backlight display setting should be set to the shortest time to preserve the battery life.

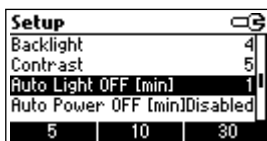

Auto Power OFF

This selection can be used to preserve the battery life in the event that the meter is accidentally left on.

Highlight *Auto Power OFF*.

Press **Modify**.

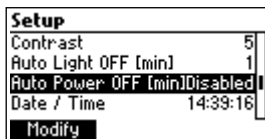

Use ▲/▼ keys to select interval, then press **Accept**.

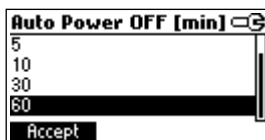

Press **ESC** to leave without changing.

Date / Time

This parameter should be configured to the current date and time prior to connecting a [HI764113](#) probe for the first time.

To set the time and /or date, from the *Setup* menu, highlight *Date / Time*, then press **Modify**.

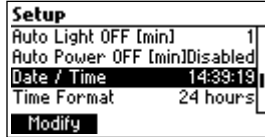

Use ←/→ keys to select item. Use ▲/▼ keys to change the emphasized values.



Press **Accept** to confirm the new settings, or **ESC** to leave without changing.

Time Format

Your desired time format may be selected in this parameter. Highlight *Time Format* from *Setup* menu. Select between *AM/PM* or *24 hours*.

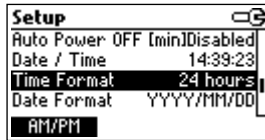

Press functional key to change the option.

Date Format

Your desired date format may be selected in this parameter. Highlight *Date Format* from *Setup* menu and press **Modify**.

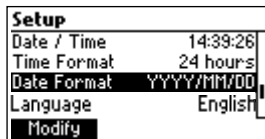

Highlight desired date format using ▲/▼ keys then press **Accept**.

Press **ESC** to leave without changing.

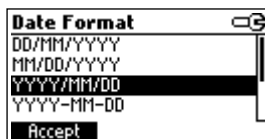

Language

This option allows the user to choose the desired language in which all information will be displayed. To modify the language, highlight *Language* from the *Setup* menu and press the desired virtual key to make selection.

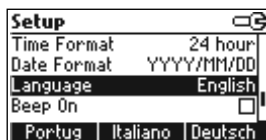

Beep On

This option allows the user to turn an acoustic warning signal on or off. If enabled, a short tone will occur to signal a condition is correct (key press, calibration) or a long tone will occur when an incorrect key is pressed.

Disabling will silence audible signals.

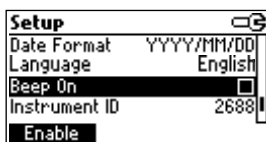

Instrument ID

This parameter allows the user to set a four digit code to easily identify the meter.

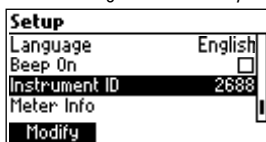

Press **Modify**, then use **▲/▼** keys to change the meter's ID. Press **Accept** to confirm or **ESC** to exit without saving.

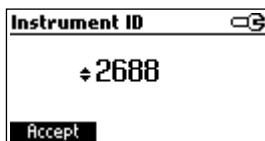

Meter Info

This parameter captures the firmware version, language version, pressure calibration date, meter serial number as well as the battery capacity.

Highlight the *Meter Info* then press **Select**.

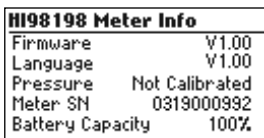
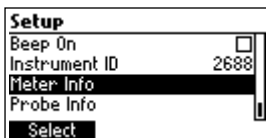

Probe Info

This parameter displays probe and Smart Cap™ information.

Press **Select** to view cap information.

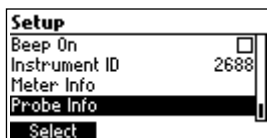

Press **Next** to view the **Cap** information.

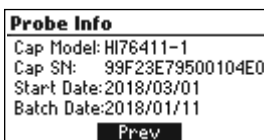
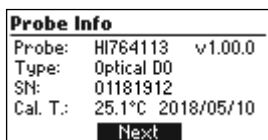

Press **Prev** to return to first screen.

Press **ESC** to return to *Setup*.

Press **ESC** two times to return to *Measurement*.

There are three calibration functions and procedures that can be accessed through the **CAL** button. These are calibration of the probe (*DO*), calibration of the barometer (*Pressure*) and calibration of the temperature (*Temp*). Prepare the dissolved oxygen probe according to the instructions from **GETTING STARTED** (page 11).

No conditioning period is required when using a **HI764113 DO** probe.

Store the **HI764113** probe in the **HI98198** carrying case when not in use. For short term storage the probe can also be stored in a beaker of deionized water or in storage cap (when shield is removed).

DO CALIBRATION

General Calibration Guidelines:

1. Before calibration, rinse the probe with clean water to remove debris from the probe body; wipe with a lint free cloth.
2. Remove the protective shield and set aside.
3. Inspect. Visually inspect the Smart Cap™ for biofouling. If necessary, use a mild detergent and a soft bristled toothbrush to clean the probe and Smart Cap™. A scratch in the black protective layer on the Smart Cap™ will affect the calibration (and measurement). Replace the Smart Cap™ if the sensing surface has been compromised.
4. Rinse the cap with water after cleaning and dry with a laboratory tissue.
5. Discard zero oxygen solution in an appropriate manner after use (do not return to bottle). Follow local disposal regulations.
6. Confirm all water droplets have been removed from the cap surface as well as the temperature element before performing the calibration procedure in water saturated air.

Calibration of the **HI764113** optical dissolved oxygen probe may be performed several different ways:

- Single point automatic zero calibration at 0% saturation or 0 mg/L
- Single point automatic slope calibration at 100% saturation or 8.26 mg/L
- Two points automatic calibration at 0% saturation (0 mg/L) and 100% saturation (8.26 mg/L)
- Single point manual calibration using a standard value set by the user in % saturation or mg/L.

Any 0% (or mg/L) calibration is made exposing the probe to an environment with the absence of oxygen (such as Hanna **HI7040** solution), a nitrogen sparging, or other oxygen scavengers.

A 100% calibration is best made in water saturated air, however air-saturated water is also acceptable.

A single point manual calibration may be made by comparing the displayed value to a determination made by a reference method (such as the Winkler titration), or a reference probe in the same sample.

Notes: Temperature and Pressure calibration (if required) should be made prior to the probe calibration. Before attempting the calibration, the probe and standards must be prepared.

Remove the protective guard from the probe.

For 100% calibration, water-saturated air is the simplest method (and recommended method). It involves suspending the probe over a contained surface of water or moistened absorbent material. The temperature element should also be inside the container. Under equilibrium conditions, the partial pressure of oxygen in air-saturated water is equal to the partial pressure of oxygen in water-saturated air; a probe calibrated in water-saturated air will correctly read the partial pressure of oxygen in water samples.

Note: performing the calibration in dry air will introduce an error because reference compensations are based on air containing 100% relative humidity.

Place a moistened sponge into the bottom of the Hanna storage/calibration vessel, or place deionized water into the bottom of the small bottle or flask, then suspend the probe into the vessel.

Warning: DO NOT tighten the calibration vessel on the probe thread as the water vapor will become pressurized. If using water, verify the probe Smart Cap™ has not been moistened. Wait a minimum of 15 minutes for the air to become saturated with water vapor.

Calibrating the probe over a large water surface, such as a lake or aeration basin used in wastewater treatment should also suffice.

Air-saturated water can be produced by bubbling air into a water sample for a prolonged period. The point at which the water is completely saturated is difficult to estimate so there is a risk of under or over saturation (if the temperature changes).

Single point automatic zero calibration

Submerge the probe into HI7040 zero oxygen solution and stir gently for 2-3 minutes. Wait for the temperature and probe values to become stable.

Press **CAL**. The calibration menu will be displayed.

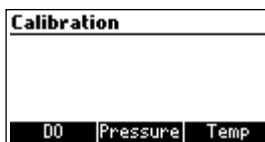

Press **DO** to select the DO calibration. The meter will automatically recognize the 0% standard.

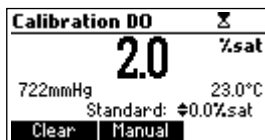

The *DO* calibration screen will be displayed and the standard 0% saturation (or 0 mg/L, depending on the currently selected measuring unit), will be automatically selected.

When the reading is stable within the acceptable range, the *CFM* functional key is displayed.

Press **CFM** to confirm the calibration point.



Press **ESC** to leave calibration or continue for a two point calibration.

The probe must be rinsed thoroughly with purified water to remove all traces of the zero calibration solution.

Single point automatic slope calibration at 100%

Suspend the probe into the water saturated air container and wait for the probe and sample to reach thermal equilibrium.

Press **CAL**. The calibration menu will be displayed.

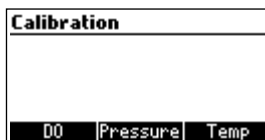

Press **DO** to select the *DO* calibration. The meter will automatically recognize the 100% saturated standard (or equivalent mg/L).

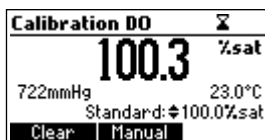

The *DO* calibration screen will be displayed and the standard 100% saturation (or 8.26 mg/L, depending on the currently selected measuring unit), will be automatically displayed.

When the reading is stable within the acceptable range, the *CFM* functional key is displayed.

Press **CFM** to confirm the calibration point.



Two points automatic calibration at 0% saturation (0 mg/L) and 100% saturation (8.26 mg/L)

Note: if performing the two point calibration, the 0 point must be done first.

Submerge the probe into HI7040 zero oxygen solution and stir gently for 2-3 minutes.

Press **CAL**. The calibration menu will be displayed. Wait for the temperature and probe values to become stable.

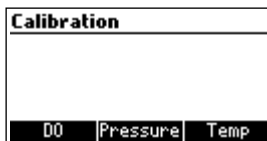

Press **DO** to select the *DO* calibration. The meter will automatically recognize the 0 standard.

The *DO* calibration screen will be displayed and the standard 0% saturation (or 0 mg/L, depending on the currently selected measuring unit), will be automatically selected.

When the reading is stable within the acceptable range, the *CFM* functional key is displayed.

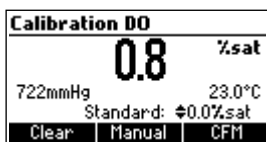

Press **CFM** to confirm the calibration point.

Remove probe from the standard and rinse it off completely in running water to remove all traces of zero standard. Blot any water off the cap with a lint free tissue.

Suspend the probe into the water saturated air container and wait for the probe and sample to reach thermal equilibrium.

The meter will automatically recognize the 100% saturated standard (or equivalent mg/L).

The standard 100% saturation (or 8.26 mg/L), will be automatically displayed.

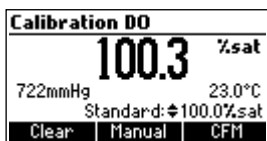

When the reading is stable within the acceptable range, the *CFM* functional key is displayed.

Press **CFM** to confirm the calibration point. The meter will return to the measurement screen and the probe will store the calibration data.

Single point manual calibration

Determine the dissolved oxygen value of the sample using a reference method such as the Winkler titration. Place the HI764113 probe in a sample, lake, basin, stream etc. that a recent dissolved oxygen determination has been made. The probe should be at thermal equilibrium with the sample.

Press **CAL**. The calibration menu will be displayed.

Press **DO** to select the *DO* calibration.

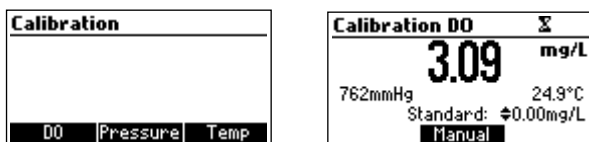

Press the **Manual** functional key.

Using the ▲/▼ keys, adjust the standard value to the value determined previously.



When the reading is stable, the *CFM* functional key is displayed.

Press **CFM** to confirm the calibration point. The meter will return to the measurement screen and the probe will store the calibration data.

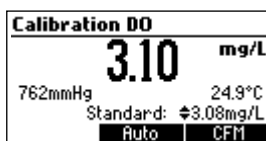

Pressure calibration

The HI98198 meter incorporates a pressure transducer that accurately tracks local barometric pressure. Oxygen partial pressure is influenced by the local barometric pressure as dictated by Henry's Law. The HI98198 automatically compensates dissolved oxygen measurements for these changes. The HI98198's pressure transducer is factory calibrated and no user calibration should be necessary. If the pressure reading appears out of tolerance, the pressure reading can be checked and a calibration performed if required. To calibrate pressure follow the instructions below. A reference barometer with at least 1 mmHg resolution is required.

Press **CAL** from any measure mode (*DO*, *BOD*, *OUR* or *SOUR*). The calibration menu will be displayed.

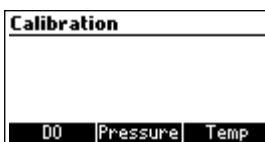

Press **Pressure** functional key to select the pressure calibration. The pressure calibration screen will be displayed.

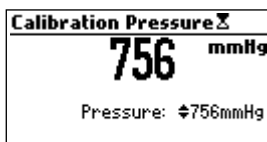

Using the ▲/▼ keys, enter the true local barometric pressure reading from the reference barometer. **DO NOT** use the pressure reported by the weather bureau. Weather bureaus correct pressures to sea level.

When the reading is stable within range of the entered barometric pressure the **CFM** functional key is displayed.

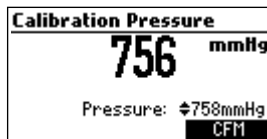

Press **CFM** to confirm the calibration.

The meter will return to the measurement screen and will store the calibration data.

"**CAL DUE**" will be displayed and a probe calibration must follow.

To clear the pressure calibration and restore the factory one, press **CAL** from any measure mode (*DO*, *BOD*, *OUR* or *SOUR*).

The calibration menu will be displayed. Press the **Pressure** functional key and then **Clear**.

The user calibration will be removed and the factory calibration restored.

Press **ESC** key at any time to exit the calibration without changing values.

Temperature calibration

The **HI764113** has been factory calibrated for temperature. Dissolved oxygen values are based upon temperature compensation so accurate temperature measurements are required. Should a thermistor go out of tolerance, your measurement will be compromised. An additional user temperature calibration of the **HI764113** optical dissolved oxygen probe may be performed if desired.

The probe has a built-in temperature sensor and the thermal transfer is made via the stainless steel contact located on the probe body. The contact point must be fully immersed in solution and in thermal equilibrium with the solution measured during calibration. The greater the difference between the temperatures at which the probe was stored and the temperature of the sample, the longer it will take to reach thermal equilibrium. When the probe is connected to the meter and the meter is powered, the temperature is displayed. Observe when temperature is stable before conducting a temperature calibration. A reference thermometer with 0.1 °C (or better) accuracy is suggested.

Note: Calibration data for temperature is stored in the probe memory.

Procedure:

Remove the protective shield from probe. Place **HI764113** probe and the reference thermometer into a stirred container of water. Ensure the temperature contact on the probe is submerged in the water.

Observe the temperature on display until it stops changing (this may take several minutes).

Press **CAL** from any measure mode (*DO*, *BOD*, *OUR* or *SOUR*). The calibration menu will be displayed.

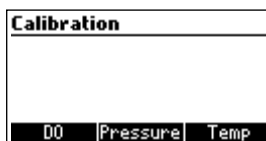

Press the **Temp** functional key to select the temperature calibration.

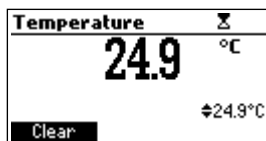

Use the ▲/▼ keys to set the calibration point values to that of the reference thermometer. When available, *CFM* will appear on the display.

Press **CFM** to complete the calibration.

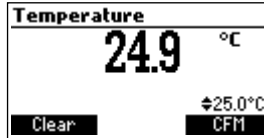

To clear the user temperature calibration at any time, press **CAL** from any measure mode (*DO*, *BOD*, *OUR* or *SOUR*). The calibration menu will be displayed. Press the **Temp** functional key then **Clear**. The previous user calibration has been removed and the factory calibration restored.

Press **ESC** button at any time to escape from the calibration without changing values.

"**CAL DUE**" will be displayed and a probe calibration must follow.

GLP is a set of functions that allows storage and retrieval of data regarding the calibration of the *DO* probe.

All data regarding *DO* calibration is stored for the user to review when necessary.

Last *DO* calibration data

Data from the last 5 *DO* calibrations are stored automatically after a successful calibration. To view the last calibration data, press **GLP** when the meter is in the *DO*, *BOD*, *OUR* or *SOUR* measurement mode. The last calibration will appear at the top of the list.

The meter will display *GLP* data related to the calibration including calibration standards, salinity, pressure and temperature.

Use ▼ to scroll through previous calibration records. A total of five calibrations are stored for reference.

GLP DO 1/1	Standard
Date: 2018/05/07	100.0%sat
Time: 17:04:54	
Salinity: 0PSU	
Pressure: 760mmHg	
Temperature: 25.0°C	

GLP DO 1/4	Standard
Date: 2018/05/14	8.26mg/L
Time: 16:06:12	0.00mg/L
Salinity: 0PSU	
Pressure: 738mmHg	
Temperature: 12.0°C	

MEASUREMENT

Measurements can be made simply and quickly with a calibrated [HI764113](#) and [HI98198](#). The **AutoEnd** key can freeze data with a single touch, and the measurement units changed by pressing the Range key.

Power the **opdo™** meter with the probe connected. After initialization, the meter enters in measurement mode. Place the probe in the sample to be measured and allow it to reach thermal equilibrium with the sample.

Direct measurements of dissolved oxygen (as % saturation or mg/L), temperature and atmospheric pressure are shown on the **opdo™** meter display.

Range Key

Pressing the **RANGE** key while in measurement toggles the measurement between a percent saturation or concentration (mg/L) measurement. The concentration measurement is calculated for oxygen dissolved in water and is based upon air saturated water. If measuring other fluids (not water), the mg/L measurements will be in error. In those cases the % saturated reading should be used.

AutoEnd

AutoEnd allows the user to display a measurement with a hold function. This is useful when you are taking a measurement in a location where it might be difficult to write down the measurement. Pressing **AutoEnd** will suspend the reading on the display until it is cleared.

To suspend a stable reading on the display press **AutoEnd** while the meter is in *DO* measurement.

The “**Wait**” symbol will blink until the reading is stable.

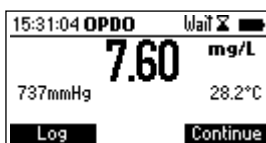

When the reading is stable “**Hold**” indicator will be displayed.



Press **Continue** to resume live readings.

Mode Key

Repetitive presses of the **MODE** key changes the direct measurement into one of three available dissolved oxygen applications: *BOD*, *OUR*, and *SOUR*. See page 41 for *BOD*, page 46 for *OUR*, and page 49 for *SOUR* for application specifics.

This feature allows the user to log *DO*, *BOD*, *OUR* and *SOUR* measurements. All logged data can be transferred to a PC using the USB Type C port.

Transfer is simple as the computer recognizes the USB connection. A spreadsheet program such as Excel makes integration of the computer with the meter simple.

The maximum number of records is 4000.

LOGGING THE CURRENT DATA

To log the current measurement press the **LOG** key.

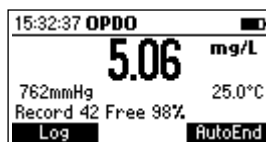
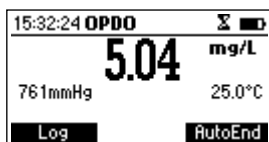

The meter will display for a couple of seconds the record number and the amount of free space (in %). If the maximum number of stored measurements is achieved, the “**Log space is full**” message will be displayed for a few seconds when **LOG** key is pressed.



Enter *RCL* mode and delete records in order to free log space.

VIEW LOGGED DATA

Press **RCL** to retrieve the stored data while in the measurement mode (*DO*).

The list of records is displayed in the range it was measured (% sat. or mg/L).

Use **▲/▼** to select the desired record.

DO	Unit	Date
5	3.76 mg/L	2018/05/28
6	3.09 mg/L	2018/05/28
7	59.7 %sat	2018/05/28
8	61.1 %sat	2018/05/28

Delete All Delete More

Press **Delete All** to enter *Delete All* screen. Press **CFM** to clear all logged records.

Delete all records?		
20	7.43 mg/L	2018/05/18
21	7.43 mg/L	2018/05/18
22	7.43 mg/L	2018/05/18
23	7.43 mg/L	2018/05/18

CFM

Press **Delete** to enter *Delete* the selected screen. Press **CFM** to delete record.

Delete Record?		
20	7.43 mg/L	2018/05/18
21	7.43 mg/L	2018/05/18
22	7.43 mg/L	2018/05/18
23	7.43 mg/L	2018/05/18

CFM

Press **More** to view more information of the selected record.

Press **Pg Down** to see additional information.

Record number: 21	
Date:	2018/05/18
Time:	16:24:02
DO:	7.43mg/L
Temperature:	24.7°C

Export Pg Down

To export data to an USB drive or PC, see the next sections.

If there is no logged data, the meter will display “No Records”.

DO log on demand
No Records!

DO recall:

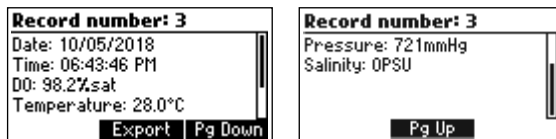

METER TO PC

Logged data on **opdo™** can be transferred from the meter to a PC by following these simple directions. Suitable operating systems include Windows (XP or newer), OS X or Linux.

1. Connect **opdo™** to the PC using the supplied USB-A to USB-C cable.
2. Turn on **opdo™**.
3. The meter will display “Connected to HOST”

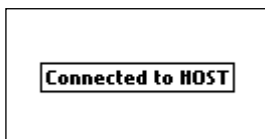

The PC should detect the USB as a removable drive. Open the drive to view the stored files. Log files are formatted as Comma separated values (*.CSV) and can be opened with any text editor or spreadsheet program.

(Note: Field separator may be set as comma or semicolon depending upon region preferences, see SETUP.)

Note:

1. *Western Europe (ISO-8859-1) character set and English language are suggested settings.*
2. *Other files may be visible depending upon computer settings. All files stored will appear in this folder.*
3. *Adjust Font or column width appropriately.*

METER TO USB DRIVE

The logged data can be transferred from the meter to a USB Flash Drive. In order to transfer all the logged data onto a USB Flash Drive insert USB-C into opening on the top of meter. Press the **RCL** key and using **▲/▼** keys highlight any log.

DO	Unit	Date
7	59.7 %sat	2018/05/28
8	61.1 %sat	2018/05/28
9	54.7 %sat	2018/05/28
10	4.56 mg/L	2018/05/28

Delete All Delete More

Press the **More** function key then press **Export**.

Record number: 3
Date: 10/05/2018
Time: 06:43:46 PM
DO: 98.2%sat
Temperature: 28.0°C
Export Pg Down

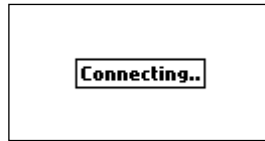

If the file is already saved on the flash drive, **opdo™** will ask for confirmation of overwriting the existing file. The message "FILE EXISTS! OVERWRITE?".



Press **CFM** for overwriting the existing file.

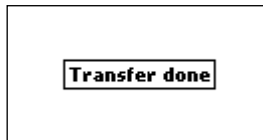

Note: Do not remove the USB Flash Drive during the file transfer.

If the USB is not found the following screen will appear.

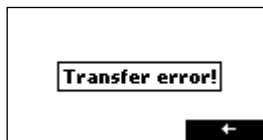

Try reseating USB drive and pressing **Export** again.

DISSOLVED OXYGEN MEASUREMENTS:

1. Select measurement units of convenience. Press **SETUP** to change temperature or pressure measurement units (see page 16 and 17).
2. Press **RANGE** to access the preferred measurement units; mg/L or % saturation.
3. Routinely inspect probe for biofouling. Routinely clean off the probe with clean water (between measurements). Biologically active waters may require more frequent cleanings. Ensure weeds, debris, or other materials are not coating the protective guard as this will block sample circulation preventing sample from reaching the active measurement surface.
4. Verify pressure and temperature measurements are reading correctly and that the probe has been calibrated in accordance with sampling protocols.
5. When measuring across a temperature gradient, (i.e. the car is hot and the waters cool), allow the probe to come thermal equilibrium with the water being sampled.
6. The HI98198 with HI764113 have been designed for dissolved oxygen water quality measurements in urban and natural waters. It may be used for discrete spot sampling using the meters Log on Demand function. The maximum depth rating for the probe is 20 m and should be adhered to.
7. Select a water sampling site that will have a representative sampling. Position the probe if possible, facing flow to minimize bubble collection or fluid cavitation. The probe should be measuring the partial pressure of the dissolved oxygen in water. Gas bubbles have a greater partial pressure due to the surface tension of the bubble. Noisy or erratic measurement or higher measurements are possible.

BOD MEASUREMENTS

Biochemical oxygen demand (*BOD*) is an indicator for the concentration of biodegradable organic matter present in a sample of water. It can be used to infer the general quality of the water and its degree of pollution. *BOD* measures the rate of oxygen uptake by microorganisms in a sample of water at a fixed temperature and over a given period of time. To ensure that all other conditions are equal, a very small amount of microorganism seed is added to each sample being tested. This seed is typically generated by diluting activated sludge with deionized water. The samples are kept at 20 °C in the dark and tested for dissolved oxygen (*DO*) after five days. The loss of dissolved oxygen in the sample, once corrections have been made for the degree of dilution, is called the BOD_5 .

Before measuring *BOD*, remember to set the *BOD* configuration from the *Setup* menu (see page 18).

BOD PROCEDURE

DAY 0 (CAL DO)

Go to *Setup* and configure *BOD configuration* parameter which sets up expected sample and seed concentrations.

Determine if you wish to save all *BOD* data or automatically delete starting data. Go to *Setup* and configure Autodelete *BOD* start data.



Press **MODE** to access the *BOD* measurement screen.

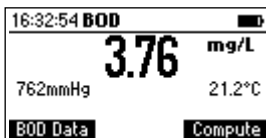

Press **BOD Data**. The following screen will open. Place the probe into the *BOD* sample and allow the measurement to stabilize. The sample should be well mixed. Follow all standard operating procedures.

Press **Add new**. The following screen will open and all parameters have to be filled out.

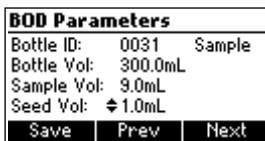
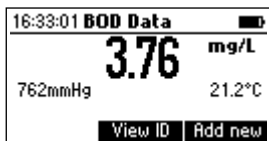

BOD Parameters:

- **Bottle ID:** a number used to identify a specific bottle.
Range: 0000 to 9999.
- **The type of the Sample:** Sample or Seed.
- **Bottle Volume:** the total volume of the *BOD* bottle.
Range: 0.1 to 300.0 mL.
- **Sample Volume:** the volume of sample in the *BOD* bottle.
Range: 0.1 to 300.0 mL (for a seed sample this value is 0.0 mL and cannot be set).
- **Seed Volume:** the volume of seed in the *BOD* bottle.
Range: 0.0 to 300.0 mL.

Press **Prev/Next** to select a different parameter on the screen.

Press **▲/▼** keys to modify the selected parameter's value.

Press **Save** to save the *BOD* parameters and the initial *DO*, temperature, pressure and salinity values for the specified bottle. If a bottle with the same ID already exists, the meter will ask for replacement confirmation.

Press **Replace** to replace the existing record, or **ESC** to return to the previous screen without replacing.



When a new record is saved the meter will display a message indicating the remaining free *BOD* initial data space in %.

Repeat procedure with additional samples: Rinse off probe between samples. Place the probe into the *BOD* sample and allow the measurement to stabilize. The sample should be well mixed. Follow all standard operating procedures.

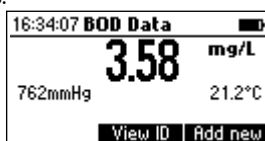

Press **Add new** and complete *BOD* Parameters screen (see above). Press **Save** log initial data from this sample. Prepare all sample bottles for incubation.

Remove probe from sample and fill and cover to prepare bottle for incubation.

Rinse probe off with purified water. If desired, move probe to next sample. Press and repeat this procedure on additional samples and Seed samples.

At the conclusion of Day 0 the probe should be cleaned and stored and all samples should be incubated following Operational Procedures.

Day 5 (Final DO)

Remove samples and Seed samples from the incubator for analysis.

Press **MODE** to display *BOD*. Press **CAL** then **DO** to calibrate the *DO* probe.

Place cleaned and dry probe in sample to be evaluated.



Press **Compute**. The list of the Day 0 samples and seeds will be present. Use the ▲/▼ keys to scroll the list of *BOD* initial data records. The seed records will have the symbol “*” displayed after the bottle ID.

ID	DO(mg/L)	Date
0023	3.02	28/05/2018
0024	2.92	28/05/2018
0025	2.85	28/05/2018
0026	2.52	28/05/2018

Delete All **Delete** **More**

Press **More** to view detailed information for the selected record.

Select the *Bottle ID* that is currently being measured by the probe and press **EvalBOD**.

ID	DO(mg/L)	Date
0024	2.92	28/05/2018
0026	2.52	28/05/2018
0030	3.74	31/05/2018
0031	3.76	01/06/2018

Eval. BOD More

The *BOD* will be calibrated.

ID: 0031 BOD Result	
17.33	mg/L
Start DO: 3.76mg/L	
End DO: 3.24mg/L	

Log

Press **RCL** while in the *BOD* application.

BOD recall:

ID	BOD(mg/L)	Date
0031	17.33	05/06/2018
0030	21.00	06/06/2018

Delete All Delete More

ID: 0030, Sample, not S.C.	
BOD: 21.00mg/L	
Bottle Vol: 300.0mL	
Sample Vol: 7.0mL	
Seed Vol: 1.0mL	

Correct Export Pg Down

ID: 0030, Sample, not S.C.	
Initial Parameters:	
2018/05/31	16:31:49
DO: 3.74mg/L	Temp: 21.2°C
P: 762mmHg	Salt: 0g/L

Correct Pg Up Pg Down

ID: 0030, Sample, not S.C.	
Final Parameters:	
2018/06/06	16:36:31
DO: 3.25mg/L	Temp: 21.2°C
P: 762mmHg	Salt: 0g/L

Correct Pg Up

Note: "S.C." message in the title bar means seed corrected.

"not S.C." message in the title bar means seed not corrected.

The **Correct** functional key will be displayed if the *BOD* result was not seed corrected.

Note: For a seed corrected sample, the last page will show the Seed bottle ID used for correction.

To export to PC

Connect cable to PC and meter while in *BOD* mode. Meter will display "**Connected to Host**".

A CSV file will appear on PC with *BOD* data.

To export to USB drive

While in *BOD* mode press **RCL**. Press **More**. Place the USB into the meter and press **Export** key.

A *BOD* CSV file will be exported to USB drive.

ID: 0004, Sample, not S.C.	
BOD: 94.50mg/L	
Bottle Vol: 300.0mL	
Sample Vol: 10 mL	
Seed Vol: 1mL	

Correct Export Pg Down

Seed Correction

In case that the *BOD* was evaluated for a seeded sample and the list of the saved seed *BOD* values is not empty, the **Correct** functional key will be displayed.

Press **Correct** to view the list of the saved seed *BOD* values.

Select the desired seed *BOD* and then press **Correct** to compute the corrected *BOD* value. The meter will display the corrected *BOD* value.

If the information about the *BOD* of a certain seed doesn't exist at the moment of the *BOD* evaluation for a seeded sample, the sample's *BOD* can be corrected at a later time from the *BOD* recall menu (view logged *BOD* data).

In order to perform a seed correction from the *BOD* recall, press **RCL** key from the *BOD* measurement screen to enter *BOD* recall, select the desired *BOD* record and press **More**. The meter will display a complete set of information about the selected record.

Press **Correct** to view the list of the seed values.

Select the desired seed *BOD* and then press **Correct** to compute the corrected *BOD* value. The new *BOD* value will be displayed.

The *BOD* results with SEED correction will be displayed. Press **LOG** to save and replace the previous sample with this bottle ID or press to keep the previous sample *BOD* with no seed correction.

Clean the probe off thoroughly between samples and continue the evaluation with the next sample.

Note: Various error message will pop up if limits are exceeded.



Also if the final *DO* value is greater than the initial *DO* value an error message will be displayed.

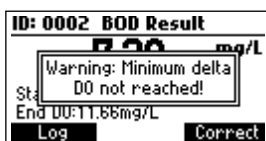
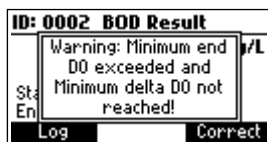
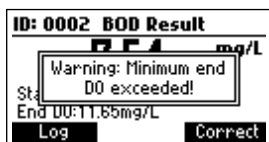

The *OUR* is used to determine the oxygen consumption or respiration rate in water. It is defined as the mg/L of oxygen consumed per hour.

The following equation is used for *OUR* determination:

$$OUR = \left(\frac{DO_{START} - DO_{END}}{t_{ELAPSED}} \right) \times \left(\frac{3600 \text{ sec}}{1 \text{ h}} \right) \times \left(\frac{\text{total volume}}{\text{sample volume}} \right)$$

where:

DO_{START} = Dissolved oxygen level at start of test

DO_{END} = Dissolved oxygen level at end of test

$t_{ELAPSED}$ = Elapsed time of test in seconds

total volume/sample volume = Dilution factor of sample

Before starting an *OUR* test remember to set the *OUR* configuration from the *Setup* menu (page 19).

This is an example of possible setting. Follow your normal SOP.

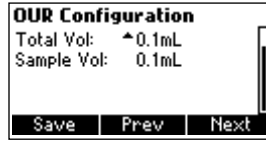
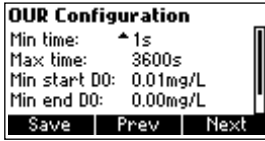

Make sure the *DO* probe has been calibrated before using. Clean off probe between samples.

Press **MODE** to select the *OUR* measurement mode. Place the calibrated probe into the airtight container of sample. Stir the sample. Press **Start** to begin taking measurements.

During the analysis the meter will display the ongoing calculation.



OUR recall:

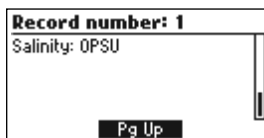
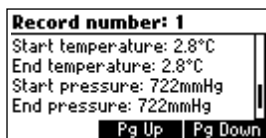
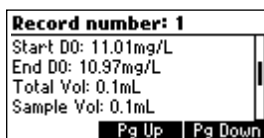
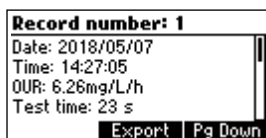
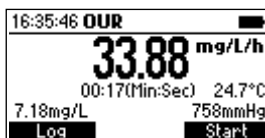

At the end of the analysis the meter will display the computed *OUR* value, the duration of the measurement, the pressure and the temperature values. Press **Log** to record a record of this analysis.



To analyze another sample, clean and dry off probe. Place probe into the next prepared sample.

Press **Start**.

OUR Error messages will be displayed anytime a measurement exceeds the limits that were configured. These will have to be reconfigured and the analysis restarted.

If the *DO* value is less than the minimum start *DO* value the meter will display an error message, and the test cannot be started

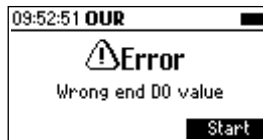
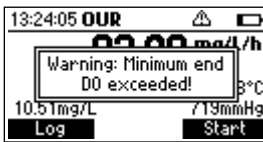
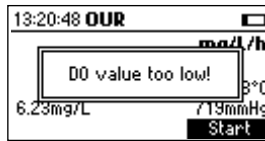

OUR[mg/L/h]	Date
10 21.60	14/05/2018
11 48.30	14/05/2018
12 39.60	14/05/2018
13 27.00	14/05/2018
Delete All	Delete More

The Specific Oxygen Uptake Rate (SOUR), also known as the oxygen consumption or respiration rate, is defined as the milligram of oxygen consumed per gram of volatile suspended solids (VSS) per hour. This quick test has many advantages: rapid measure of influent organic load and biodegradability, indication of the presence of toxic or inhibitory wastes, degree of stability and condition of a sample, and calculation of oxygen demand rates at various points in the aeration basin.

The following equation is used for *SOUR* determination:

$$SOUR = OUR / \text{Solids Weight}$$

where:

OUR is the Oxygen Uptake Rate (see equation on page 46)

Solids Weight is the **Total solids** or the **Volatile suspended solids** weight in g/L.

Temperature correction:

The *SOUR* value is corrected to 20 °C (68 °F) according to the Farrel and Bhide equation:

$$SOUR_{20} = SOUR_T \Theta^{(20-T)}$$

Where T is the measured temperature in °C and Θ is a temperature dependent variable:

$$\Theta = 1.05 \text{ for } T \text{ above } 20 \text{ } ^\circ\text{C}$$

$$\Theta = 1.07 \text{ for } T \text{ below } 20 \text{ } ^\circ\text{C}$$

This calculation is valid only for temperature values in the range 10 to 30 °C. Temperature correction is performed only if the option **SOUR @ 20 °C** is enabled.

Before starting a *SOUR* test remember to set the *SOUR* configuration from the *Setup* menu.

Make sure *DO* probe has been calibrated before using. Clean off probe between samples.

This is an example of possible setting. Follow your normal SOP.

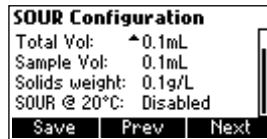
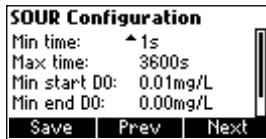

Make sure the *DO* probe has been calibrated before using. Clean off probe between samples.

Press **MODE** to select the *SOUR* measurement mode. Place the calibrated probe into the airtight container of sample. Stir the sample. Press **Start** to begin taking measurements.

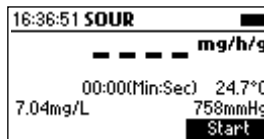

During the analysis the meter will display the ongoing calculation.



At the end of the analysis the meter will display the computed *SOUR* value, the duration of the measurement, and the pressure and temperature values. Press **Log** to record a record of this analysis.



To analyze another sample, clean and dry off probe. Place probe into the next prepared sample.

Press **Start**.

SOUR Error messages will be displayed anytime a measurement exceeds the limits that were configured. These will have to be reconfigured and the analysis restarted. Examples follow.

If the *DO* reading is less than the minimum end *DO* value set during *SOUR* configuration, a warning icon will be displayed and a beep will be heard every two seconds. Press **Stop** to stop the test and the beeper.

In case that the *SOUR* value is corrected to 20 °C (68 °F) and the measured temperature isn't in the range 10 to 30 °C the temperature value will blink to alert that the temperature correction isn't valid.

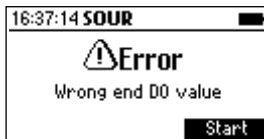

Press **LOG** to save a complete set of data regarding the *SOUR* test.

Press **Start** to begin a new *SOUR* test.

Notes: If the DO reading is less than the minimum end DO value set during SOUR configuration, a warning message will be displayed.

Press any key to clear the message from the screen, or press HELP to view detailed information about the warning.

If the DO value is greater than the DO value from the beginning of the test an error message will be displayed.

Press **Start** to begin a new *SOUR* test or *ESC* to return to the *SOUR* measure screen.

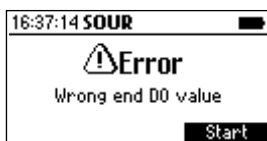

SOUR recall:

	SOUR[mg/h/g]	Date
7	18.31	14/05/2018
8	17.14	14/05/2018
9	15.32	14/05/2018
10	15.65	14/05/2018
Delete All		Delete
		More

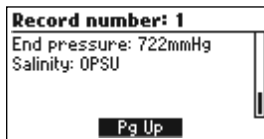
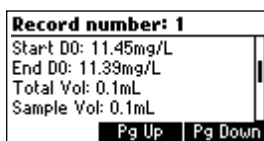
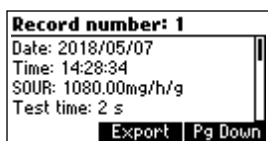

Note: In case that the SOUR value was corrected to 20 °C the message “(@20 °C)” will be displayed before the SOUR value.

To replace the batteries, follow the next steps:

- Turn OFF the meter.
- Open the battery compartment by removing the four screws from the back of the meter.
- Remove the old batteries.
- Insert four new 1.5V AA batteries in the battery compartment while paying attention to the correct polarity.
- Close the battery compartment using the four screws.

If the battery capacity is less than 10% the backlight feature is not available.

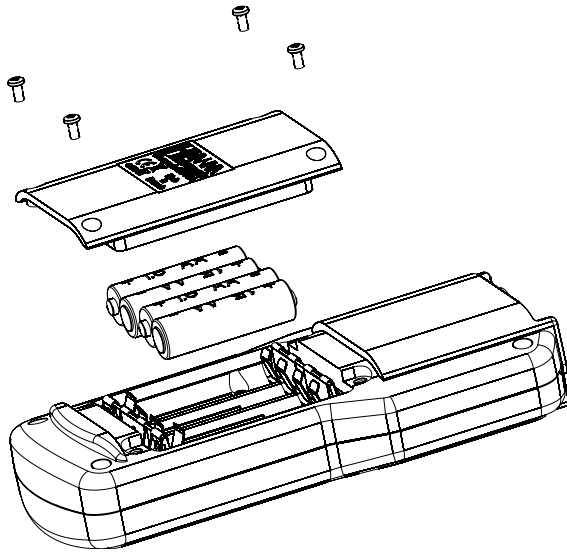

Note: The meter is provided with the BEPS (Battery Error Prevention System) feature, which automatically turns the meter off when the batteries level is too low to ensure reliable readings.

PROBE MAINTENANCE

Cleaning the HI764113 Probe Body

- Rinse the probe with clean water to remove debris from around the probe body; wipe with a soft cloth. Unscrew and remove the protective shield and set aside. Ensure weeds, debris, or other materials are not coating the protective guard as this will block sample circulation preventing sample from reaching the active measurement surface.
- The exterior of the HI764113 can be cleaned by wiping the exterior surface with a aqueous-soapy mixture and gently rubbing the exterior surface. Rinse with clean water.
The Stainless steel guard can be cleaned and polished with a cleaner suitable for stainless steel cookware or appliances. Avoid chlorine bleach containing products.

Inspection

- Routinely Inspect probe for biofouling. Carefully inspect the probe body and Smart Cap™ .
A scratch in the black protective layer on the Smart Cap™ will affect the calibration (and measurement).
Replace the Smart Cap™ if the sensing surface has been compromised.

Cleaning the Smart Cap™

- Use a mild detergent and a soft bristled toothbrush to clean the Smart Cap™ .
Rinse the cap with water after cleaning and dry with a laboratory tissue.

Yearly Replacement of the Smart Cap™ .

- Easy to use smart caps contain pre-loaded calibration coefficients that are automatically transmitted to the probe. The Smart Cap™ stores data in a RFID tag. If caps are switched between probes, no information will be lost. Smart Cap™ installation dates are easily tracked via the Probe info screen and when powering , the meter displays remaining cap life.
- Rinse the probe with clean water to remove debris from around the probe body; wipe with a soft tissue.

opdo™ Probe Replacement Cap Kit

HI764113-1

Contains:

- 1 opdo™ probe Smart Cap™
- 6 g sachet with silicone grease
- syringe
- 1 lens wipe
- 1 certification/ instruction sheet

Note: Verify time and date are properly set on meter prior to new cap initialization.

1. Unplug the **HI764113** from the **HI98198** meter. Remove the stainless steel guard from probe body and set aside. Wipe off the probe and cap with a soft tissue.

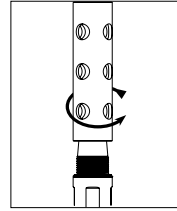

2. Remove the expired "Smart Cap™" from the probe; Squeeze the used cap at the notched V and pull it off the probe body (without twisting).

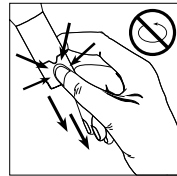

3. Remove the used O-ring from the O-ring groove by rolling it off the probe.
4. Wipe the O-ring groove with a soft tissue followed by a cleaning with the supplied lens cleaner wipe.

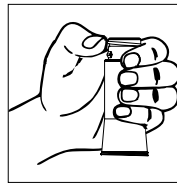

5. Remove the new O-ring from the **HI764113-1** kit and slide on probe body using care not to roll or twist the O-ring.

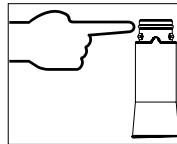

6. Remove the syringe plunger; cut top off supplied sachet with silicone grease and empty contents into the syringe. Using the syringe, sparingly lubricate the O-ring with a thin film of the supplied grease. Avoid getting any kind of grease or fingerprints onto the optical window. DO NOT SUBSTITUTE other grease/lubricants as it may cause the O-Ring to swell.



7. Clean the lens with an unused portion of the supplied lens cleaner wipe.
8. Remove the new optical cap from the box. Align the notched cutout arrow on the Smart Cap™ with the matching guide on the probe body.
9. Slide and press the Smart Cap™ onto the **HI764113** body until the cap snaps in place. Once the cap is installed, it should not be removed unless a new cap is required.

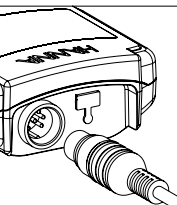

10. Connect the **HI764113** probe to the **HI98198** meter by connecting the connector to the DIN jack located on the top of the meter.

11. Power the meter to initiate the cap timer.



12. Calibrate.

13. Reinstall the stainless steel guard onto the probe body.

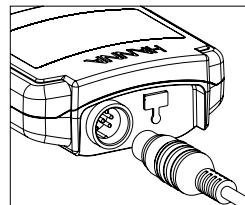

No conditioning period is required when using a [HI764113 DO](#) probe.

Store the [HI764113](#) probe in the [HI98198](#) carrying case when not in use. For frequent use and short term storage it is recommended to remove the stainless steel guard and replace with the storage vessel that has a small amount of deionized water. The probe can also be stored with the stainless steel guard on in a beaker containing deionized water.

For longer term storage, remove the stainless steel guard and replace with the storage vessel.

SYMPTOMS	PROBLEM	SOLUTION
Display shows <i>DO</i> reading blinking.	Reading out of range.	Recalibrate the meter; Check the sample is within measurable range.
Meter shuts off.	Dead batteries; Auto Power Off feature is enabled: in this case, meter shuts off after selected period of non use.	Replace batteries; Press ON/OFF .
The meter does not start when pressing ON/OFF .	Initialization error.	Press and hold down ON/OFF for about 20 seconds or disconnect and then connect the batteries.

SYMPTOMS	PROBLEM	SOLUTION
Display shows “ No Cap Detected ” .	Cap not on correctly.	Check Cap/Reseat Cap.
Display shows “ No Cap Info Detected ” with Cap.	Cannot read Cap Info.	Check Cap and Retry. Replace Cap if it continues.
Display shows “ Cap Damaged ”.	Sensor Damaged.	Try reseating cap. If this doesn’t resolve issue, replace Cap.
Display shows “ Cap Expired ”.	Cap reached lifetime use expiration.	Continue OR Replace Cap (Continuing use may result in incorrect measurements).
Display “ No Probe ”.	Probe not present/ Not connected properly.	Connect/Disconnect and reconnect probe OR Turn meter OFF then ON.
Meter shows “ Probe Err xx ” message.	Probe Internal Error.	Disconnect and reconnect probe. If problem persists replace the probe.

Code	Description
HI7040	Bi-component Zero
HI40036P	100 mL plastic beaker (10 pcs.)
HI740027P	1.5V AA batteries (12 pcs.)
HI764113	Optical <i>DO</i> probe with built-in temperature sensor, shield and 4 m (13'4) cable
HI764113-1	Smart Cap™ with O-ring
HI764113-2	Calibration/storage vessel
HI764113-3	Stainless steel protective shield
HI764113/10	HI764113 with 10 m cable
HI764113/20	HI764113 with 20 m cable
HI920016	USB Type A to C cable

All Hanna Instruments conform to the **CE European Directives**.



RoHS
compliant

Disposal of Electrical & Electronic Equipment. The product should not be treated as household waste. Instead hand it over to the appropriate collection point for the recycling of electrical and electronic equipment which will conserve natural resources.

Disposal of waste batteries. This product contains batteries, do not dispose of them with other household waste. Hand them over to the appropriate collection point for recycling.

Ensuring proper product and battery disposal prevents potential negative consequences for the environment and human health. For more information, contact your city, your local household waste disposal service, the place of purchase or go to www.hannainst.com.



Recommendations for users

Before using this product, make sure it is entirely suitable for your specific application and for the environment in which it is used. Any variation introduced by the user to the supplied equipment may degrade the meters' performance. For yours and the meter's safety do not use or store the meter in hazardous environments.

Warranty

The [HI98198](#) and [HI764113](#) are warranted for two years against defects in workmanship and materials when used for their intended purpose and maintained according to instructions. [HI764113-1](#) is warranted for 1 year. This warranty is limited to repair or replacement free of charge.

Damage due to accidents, misuse, tampering or lack of recommended maintenance is not covered.

If service is required, contact your local Hanna Instruments Office. If under warranty, report the model number, date of purchase, serial number and the nature of the problem. If the repair is not covered by the warranty, you will be notified of the charges incurred. If the meter is to be returned to Hanna Instruments, first obtain a Returned Goods Authorization (RGA) number from the Technical Service department and then send it with shipping costs prepaid. When shipping any meter, make sure it is properly packed for complete protection.

Hanna Instruments reserves the right to modify the design, construction or appearance of its products without advanced notice.

World Headquarters

Hanna Instruments Inc.
Highland Industrial Park
584 Park East Drive
Woonsocket, RI 02895 USA
www.hannainst.com



MAN98198

Printed in ROMANIA